

ALRUBAIDI Medical Corporation

Sana'a - Zubairy Str. National Bank of Yemen Building
Tel.:+967 (1) 510119 - 510344 Fax:+967 (1) 510443



Sana'a - Saif Bin Theyazan Str.
Next to Persdential Office
Tel: +967 (1) 296182
Fax: +967 (1) 296183

Hodeida - ALDAMGAH ALgadidah.
Next to Military Hospital
Tel: +967 (3) 214120
Fax: +967 (3) 220392

Taiz - Allagenat Street
Next to a Eisaei mosque
Tel: 00967 (4) 259648
Fax: 00967 (4) 259649



HITACHI
Inspire the Next

ECHELON™ 1.5 High-Field MR

ECHELON™ – the new standard in 1.5 Tesla MR

- Specifications and appearance may change without prior notice.
- Please read the instructions carefully to ensure correct operation of devices.
- This medical device requires specialist installation and maintenance.
- For product and certificate numbers of components, please consult individual component specifications.
- Sales and leasing licences are required for the sale and lease of the device.



ECHELON™ –
the new standard in 1.5 Tesla MR

Hitachi Medical Systems presents Echelon™, the fully featured high-field performance MR that incorporates powerful imaging tools to meet your current and future clinical demands.



Hitachi Medical Systems is a division of Hitachi Ltd., headquartered in Tokyo, Japan, and renowned for technological innovation. Our extensive experience and expertise in magnet, gradient and RF technology makes us a recognised leader in open MRI. We meet the latest in design and quality standards with a truly comprehensive, patient-friendly system that combines outstanding image quality with advanced clinical applications and unbeatable economical performance.

ECHELON™ – Hitachi technology and values

Echelon™ offers you superb practicality and reliability. It is even easier to use, with even greater uptime. The system capitalises on Hitachi's experience and technological superiority gained as a result of being the global leader in open MR imaging with more than 4,000 systems installed worldwide.

Hitachi technology

Ergonomic and user-friendly operating software guarantees the specialist ease of operation and high performance, even during busy clinics. Excellent image quality enables a clear diagnosis, avoiding the need for repeat examinations. The outstanding Echelon™ technology has been designed to allow easy incorporation of future applications, making it upgradeable and versatile.

Hitachi design

The wide aperture, short-bore magnet combined with gentle colours helps patients to relax and reduces anxiety. The compact design also offers major advantages for efficient siting where the available space is at a premium.

Hitachi imaging quality

Echelon™ swiftly delivers clear, high-resolution images, so users can be confident in its imaging excellence. Its proven quality and reliability offers reassurance in the daily work environment.

Hitachi economy

Excellent clinical performance and low life-cycle costs combined with high reliability reassures all customers that they have made the right decision to meet their imaging requirements, both current and future.

Hitachi uptime

To ensure maximum uptime, every Echelon™ comes equipped with Sentinel™, a continual diagnostic and monitoring system within your MR which enables our customer support team (service and application specialists) not just to respond proactively, but also to upgrade/update your system remotely.

Hitachi has achieved the perfect fusion of clinical knowledge and the latest MR technology.



ECHELON™ – a fusion of state-of-the-art technology

The central element is a high-performance short-bore super-conductive magnet with high homogeneity and low cryogenic boil-off.

Echelon™ offers the following product benefits:

- **High field combined with compact design**
to reassure your patient without compromising clinical utility
- **30/150 gradient system**
to allow short echo times, a small FOV or high matrices for maximised throughput
- **Higher-order active shim technology included**
to ensure consistently high image quality and uniform RF fat saturation
- **Scalable RF channel system with up to 32 channels**
to allow use of RAPID™ parallel imaging technology, to provide versatility to optimise workflow, and to support multi-channel coils
- **Multiple tabletop coil ports**
to allow simultaneous control of all coil elements for RAPID™ imaging
- **Powerful VERTEX™ computer system**
to enable true multi-tasking with the most powerful scan and reconstruction engine for maximum patient throughput
- **Hitachi education and support services**
to ensure that you can trust in our technology



ECHELON™ – high-level MR and high patient comfort

A high-performance MR system enabling easy patient positioning and ensuring excellent patient comfort.

Cutting edge technology HOSS™ High Order Shim System

Compensates for the effect of the patient's body on the main magnetic field. Regional shim allows the most convenient positioning for both patient and user for outstanding imaging results. HOSS™ technology is the hardware platform of the future for even more advanced imaging capabilities.

The clinical benefits include:

- Excellent image quality for all sequences
- Outstanding homogeneity over 50cm DSV
- Best RF fat saturation without compromise

Patient comfort

The short bore and large patient aperture create a convivial patient environment without compromising clinical utility. The large, high-capacity patient table comfortably supports a broad range of patient body types.

Convenient operation

The extremely long table stroke (2800mm) and wide gantry aperture (610mm) avoid the need for repositioning, enabling the user to achieve the highest possible patient throughput.

With a table weight limit of 225kg, large patients are not a problem.

A wide, fully motorised patient table with a vertical movement range of 495-852mm allows any patient to be positioned with ease.

Adjustable bore lighting and silent ventilation optimise patient comfort.



ECHELON™ – advanced technology feature HOSS™

HOSS™

Echelon™ has a regional shimming system that compensates for patient positioning and movement in the gantry. This gives professionals the freedom to concentrate on diagnostic investigation without being distracted by the patient's position.

HOSS™ (Hitachi high Order Shim System) – providing outstanding imaging results by actively correcting magnetic field distortion.

HOSS™

This active magnetic field compensator ensures

- Perfect image quality even in off-centre regions of the body
- Maintenance of high magnetic field homogeneity when the patient is inside the gantry due to regional shimming

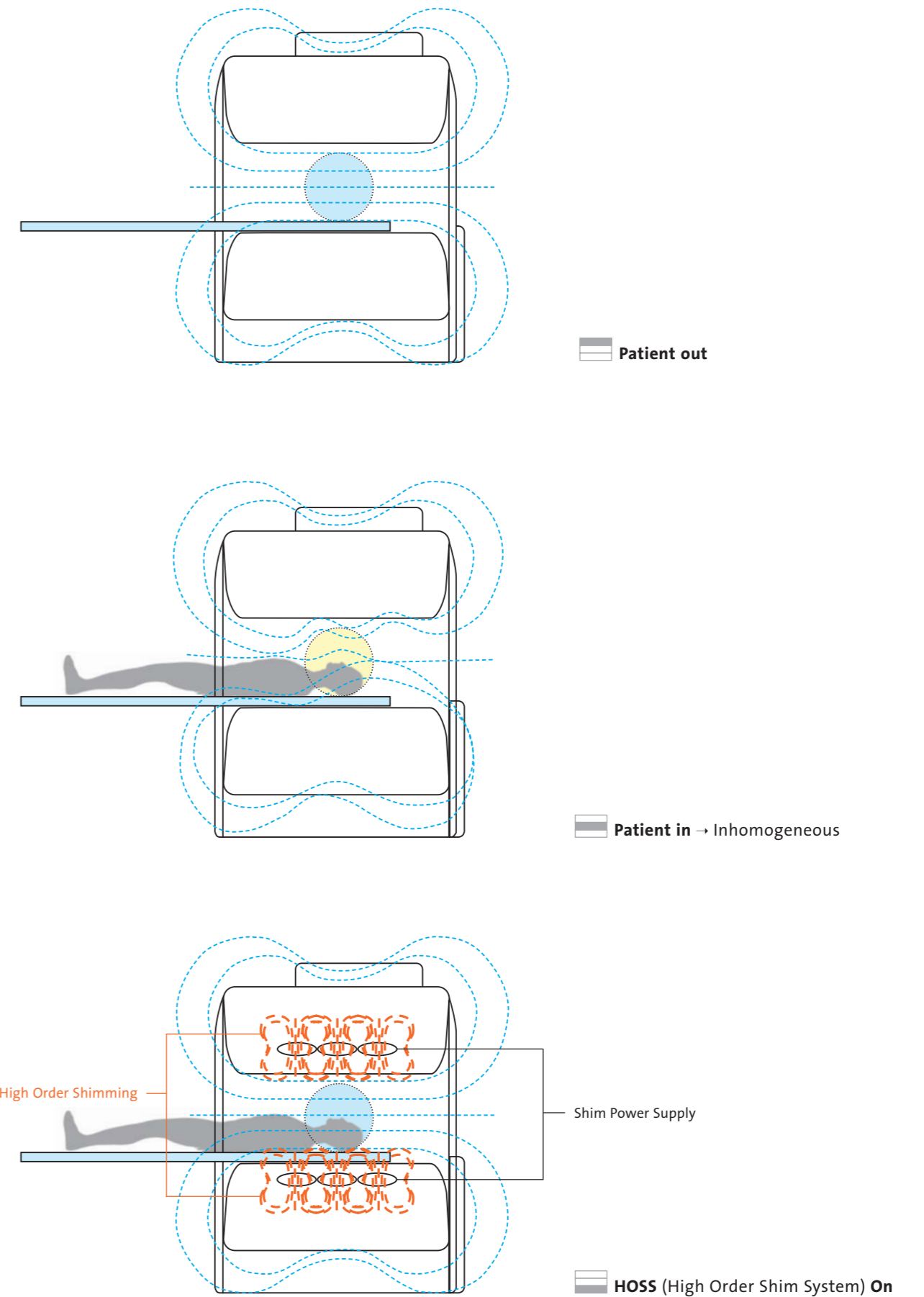

Echelon™ incorporates a broad range of techniques and features to deliver excellent image quality. This outstanding technology is designed to achieve short acquisition times and reduce artefacts.

One of Echelon's key features is the patient motion artefact reduction technique **RADAR™ (RADial Acquisition Regime)**.

RADAR™

- Can be used in orthogonal and oblique planes
- Is compatible with all RF coils
- Has user-defined parameters for maximum clinical flexibility
- Effectively reduces motion artefacts in the following cases:
 - Non-cooperative patients
 - Paediatric patients
 - Stroke patients
 - Patients with Parkinson's disease

resulting in

- Reduced swallowing and flow artefacts in head, neck and spinal imaging
- Reduced peristaltic and motion artefacts in pelvic imaging
- Reduced use of sedation for paediatric or non-cooperative patients
- Possibility of free-breathing abdominal imaging for elderly patients

Cartesian k-space filling

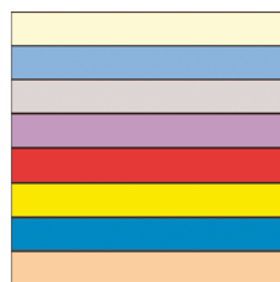

Cartesian k-space filling techniques are sensitive to patient motion, resulting in degradation of image quality and the need for repeat acquisitions.

Radial k-space filling

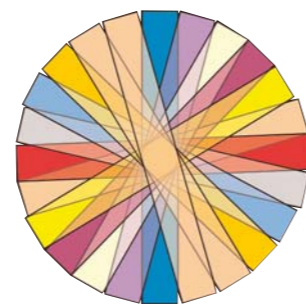

RADAR™ fills the k-space in a radial manner, with each blade crossing the centre, resulting in enhanced SNR, CNR and a reduction in patient motion artefacts.

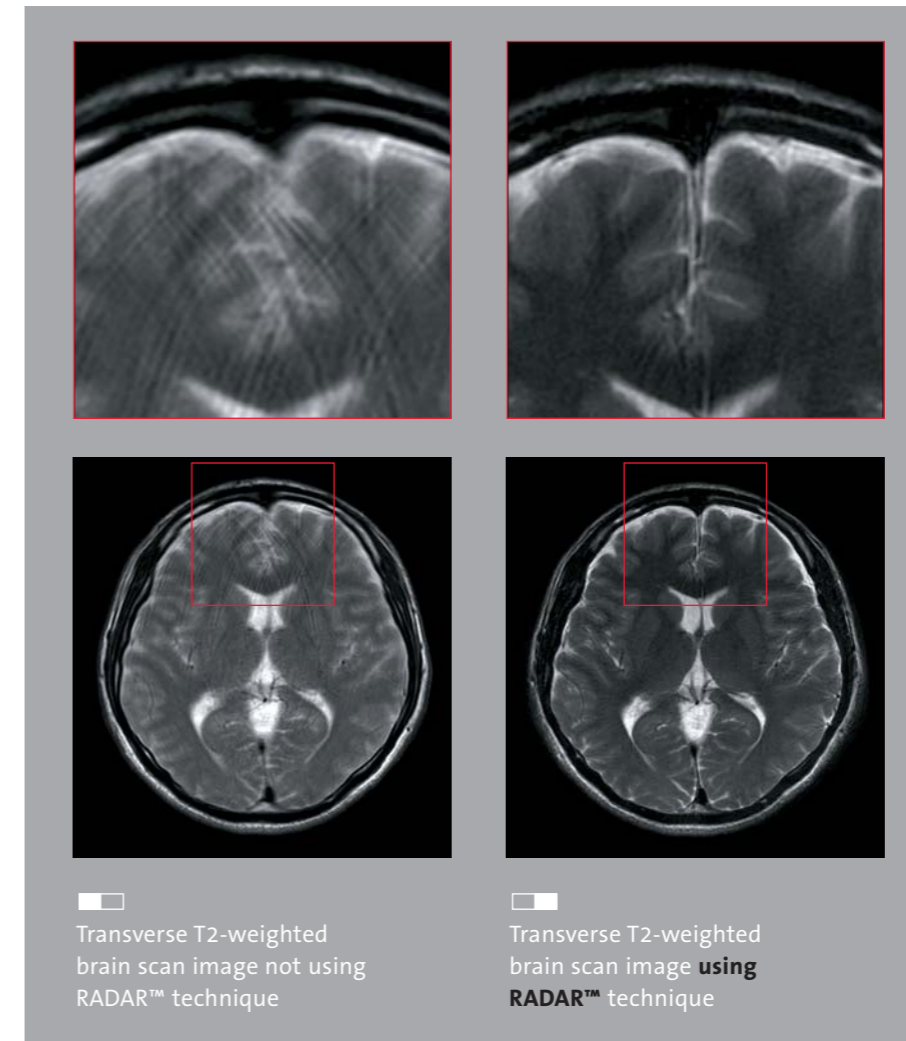

Transverse T2-weighted brain scan image not using RADAR™ technique

Transverse T2-weighted brain scan image using RADAR™ technique

Parkinson's disease using RADAR™ technique

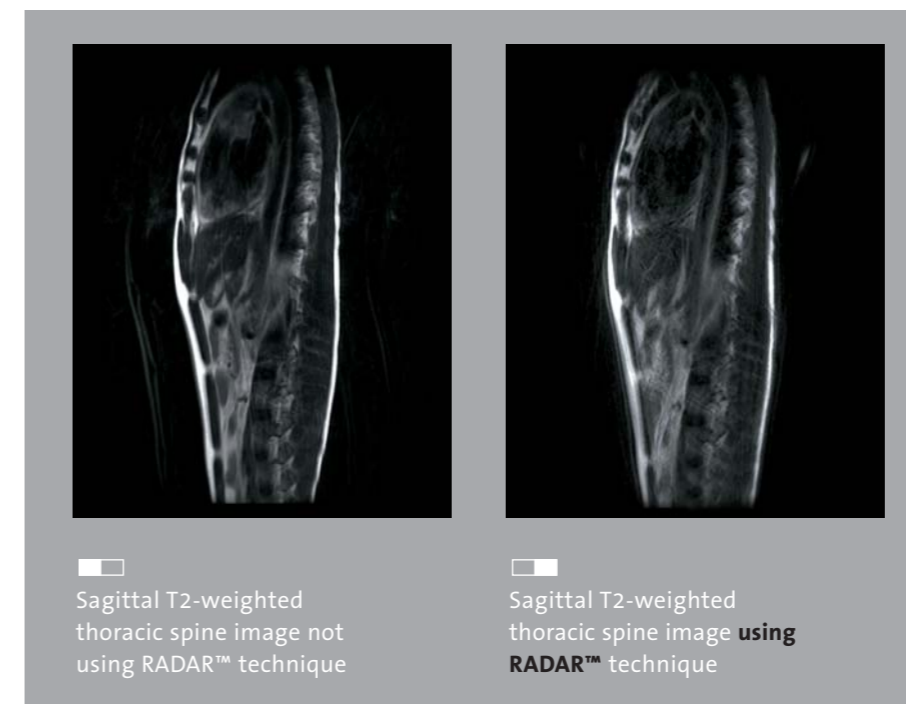

Sagittal T2-weighted thoracic spine image not using RADAR™ technique

Sagittal T2-weighted thoracic spine image using RADAR™ technique

RADAR™ technology can be used across all coils and in all imaging planes. This outstanding feature will enhance not only your image quality but also your patient throughput.

Echelon™ parallel imaging technology leads to scan time reduction and flexibility without compromising image resolution.

RAPID™

Rapid Acquisition through Parallel Imaging Design – an image-based parallel imaging technique providing additional clinical flexibility for higher spatial or temporal resolution, or shorter acquisition times for breath-hold examinations.

RAPID™ technology enhances image diagnostics for all clinical applications.

In particular, RAPID™ allows:

- User-defined acceleration factors
- Compatibility with a broad range of multi-channel RF coils
- Short diagnostic scan times and self-calibration mode

Signal-to-noise ratio (SNR) increases with number of channels used resulting in:

Decreased scan time during

- Breath-hold
- Bolus-enhanced MRA

Increased spatial resolution for

- High resolution neuro-imaging
- High resolution musculoskeletal imaging

Increased temporal resolution for

- Cardiovascular multiphase acquisitions
- Bolus-enhanced MRA

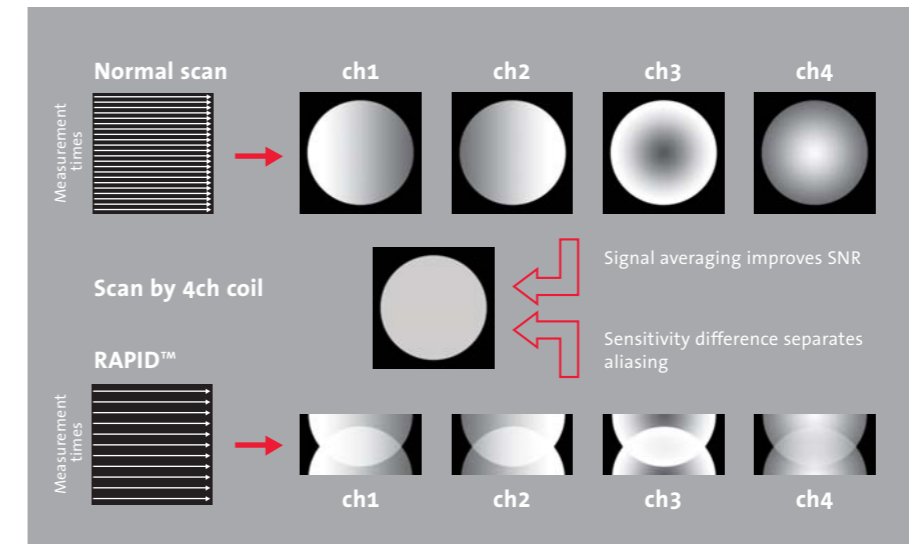

RAPID™ imaging with the use of sensitivity distribution of receiving coils

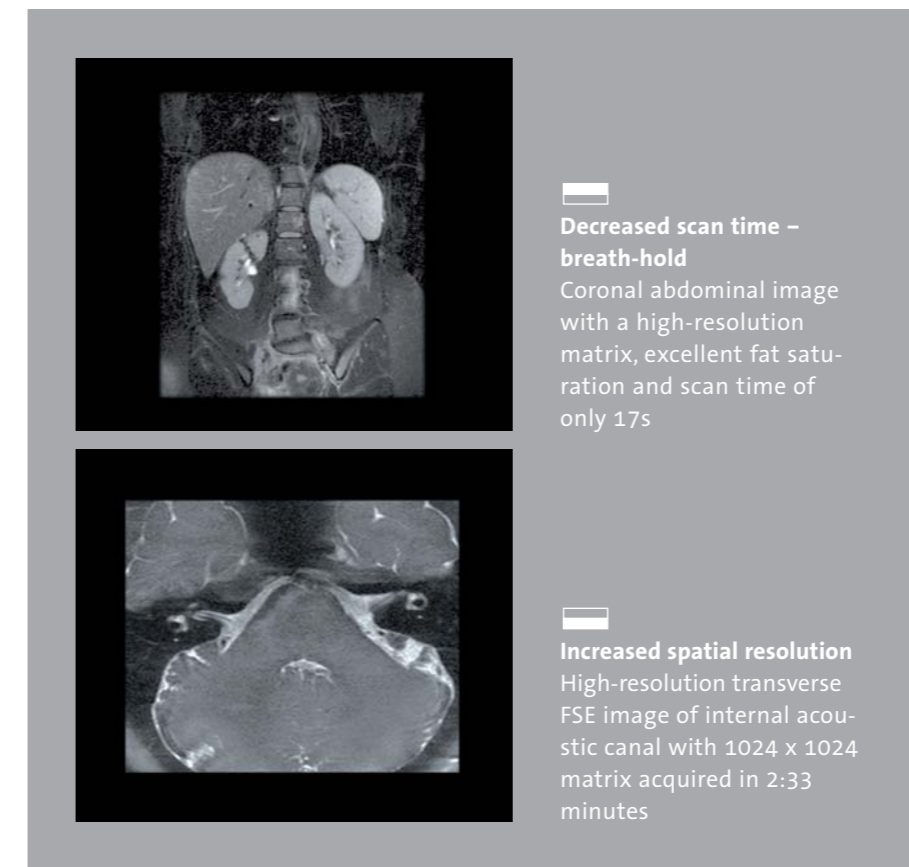

Echelon™ enables you to increase your patient throughput using RAPID™ technology for fast examinations. RAPID™ imaging is less sensitive to artefacts and can be used for all patients.

ECHELON™ – advanced diagnostic imaging packages

The wide range of packages available with Echelon™, combined with its ease of use, the outstanding image quality and the fact that it uses the most advanced technology, allow optimal workflow with accurate diagnoses for every clinical application, be it neuroradiology, cardiology, oncology or musculoskeletal imaging.

Neuroimaging package

Clinical applications

Neurological imaging of brain disorders – acute and chronic stroke, acute multiple sclerosis, psychiatric disorders (the assessment of white matter in development, pathology and degeneration), pre-operative planning for brain tumour removal – localisation of tumours in relation to the white matter tracts (infiltration, deflection).

Sequences and techniques

2D gradient echo, echo planar imaging (2D GE EPI), 2D spin echo, echo planar imaging (2D SE EPI), 2D RF spoiled sarge echo planar imaging (2D RSSG EPI), 2D contrast-enhanced perfusion weighted imaging.

Analysis software

Perfusion Analysis:

- (1) Image type: MTT (mean transit time), rCBV (regional cerebral blood volume), rCBF (regional cerebral blood flow)
- (2) Time-intensity graph display
- (3) Selectable input images on the graph
- (4) Position correction

DWI tensor analysis:

- (1) Image type: ADCaxis
- (2) Image type:
- (3 axis) ADC A-P, ADC R-L, ADC H-F, ADCtrace, DWItrace (isotropic DWI)
- (3) Image type:
- (6 axis) MD (mean diffusivity), FA (fractional anisotropy)

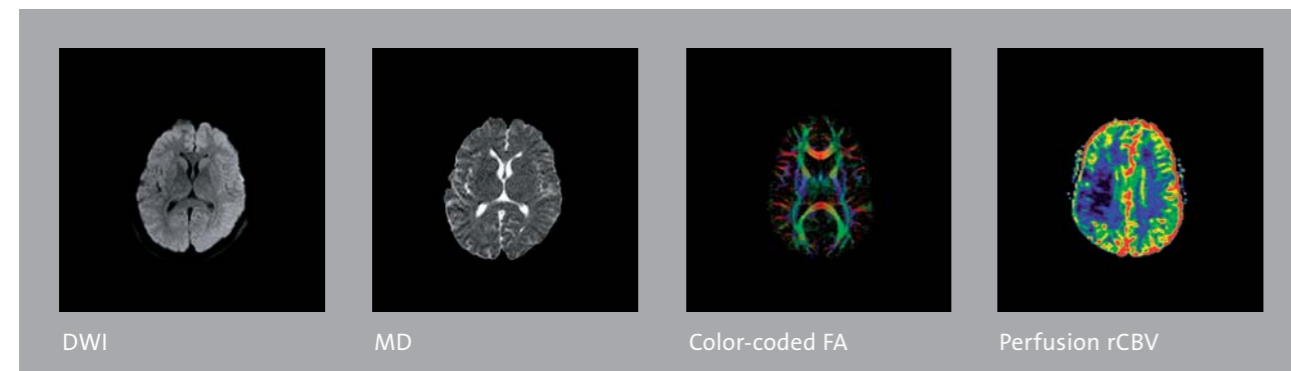

Spectroscopy package

Clinical applications

Brain tumours (determining the degree of malignancy, distinguishing tumour recurrence from radiation effects after surgery and radiation therapy), cerebral ischaemia, hypoxia and infarction, infectious diseases (abscesses, toxoplasmosis and tuberculomas, HIV infection and AIDS), Alzheimer's disease, hepatic encephalopathy, demyelinating disorders such as multiple sclerosis, epilepsy, and stroke.

Sequences and techniques

MRS-SE (spin echo) sequence with refocusing pulse 180° resulting in excellent signal-to-noise ratio. The water signal is suppressed by the CHES (CHEMical Shift Selective) technique. Fat is avoided by placing the MRS voxel within the brain, away from the fat in the bone marrow and scalp.

Analysis software

Single voxel MRS, short TE technique is used to make the initial diagnosis – excellent signal-to-noise ratio, all metabolites are represented. Graph showing spectrum of Cr, GABA, Gln, Clu, Cho, Ins, Lac, and NAA is displayed.

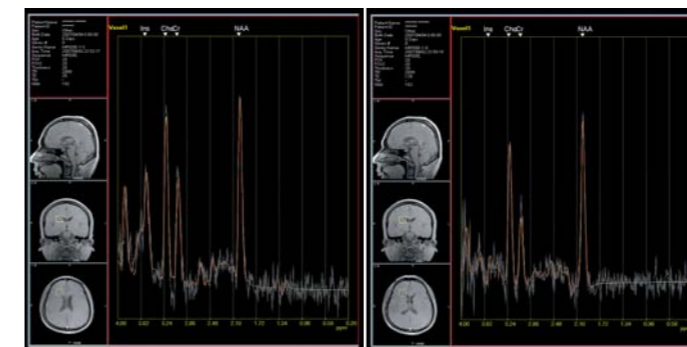

MRS – Normal volunteer



MRS – Meningioma



MRS – Multiple Sclerosis



Cardiac imaging package

Clinical applications

Heart function evaluation (ejection fraction, diastolic and systolic volume, wall thickness and wall thickening), myocardial infarction imaging, rest and stress perfusion evaluation with assessment of coronary flow reserve, cardiac masses evaluation.

Sequences and techniques

BASG, fast GE, navigator echo (for free-breathing acquisitions with reduced motion artefacts); cardiac gating for multi-slice, multi-phase; black blood imaging (double/triple IR FSE); delayed enhanced imaging; cardiac perfusion (myocardial perfusion); dynamic tissue contrast sequence – interactive scan control (possibility of changing slice sections during scanning without using any special devices or dedicated coils and of acquiring images in different anatomical positions by manual manipulation on console).

Analysis software

Cardiac MASS (ejection fraction, stroke volume, report to email, internet, CD, AVI, MPG files for interactive reporting)

Contrast-enhanced angiography package

Sequences

3D RSSG with PEak Artery enhanced K-space filling Sequence (PEAKS), 2D/3D conventional contrast-enhanced angiography, 2D/3D time resolved contrast-enhanced angiography (TRAQ™), fluoro-triggered contrast-enhanced angiography (FLUTE™).

Post-processing

MIP, MPR, vascular volume rendering

Clinical applications

Brain, carotid, pulmonary, aorta, renal, peripheral artery/vein imaging with information on anatomy and velocity of blood flow.

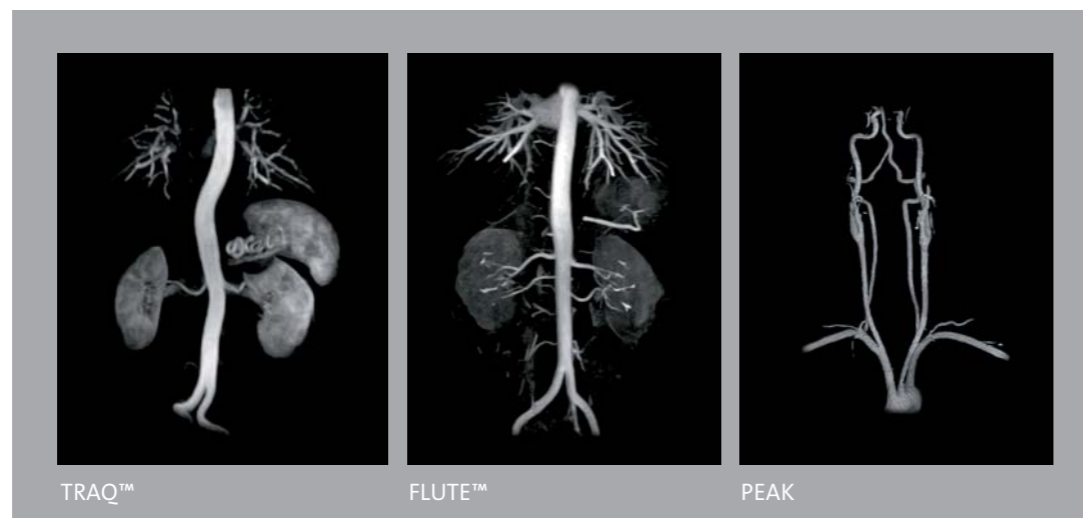
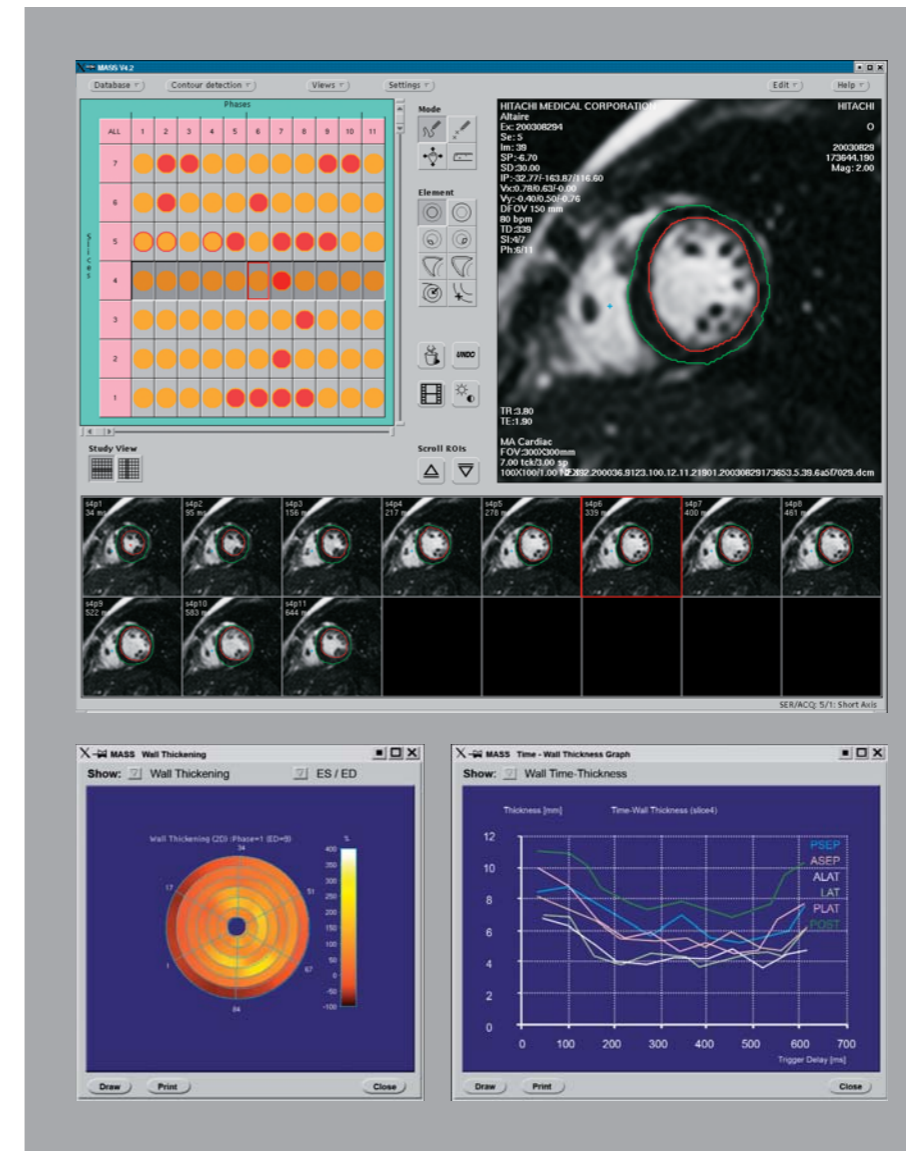

ECHELON™ – technical specifications

1 Imaging

Imaging region	Whole body
Imaging type	2DFT/3DFT
Scan matrix	64-1024 x 64-1024; 4-step increments
Multi-slice:	Maximum 256 slices
Image reconstruction time	5500 slices/s (256 x 256)
Slice thickness	0.05mm (minimum)
Imaging field	5-500mm

2 Magnet

Magnetic field type	Horizontal super-conducting magnet
Static magnetic field strength	1.5 T
Leak magnetic field (0.5mT)	2.5m x 4m (radially x axially)

3 Gradient magnetic field system

Gradient magnetic field strength	30mT/m (maximum)
Slew rate	150T/m/s (maximum)

4 Slice thickness

2D	0.7mm to 100mm
3D	0.1mm to 5.0mm
Field of View	30mm to 500mm
Time of Repetition (TR)	1.3ms to 20,000ms
Time to Echo (TE)	0.5ms – 7,680ms
Time of Inversion	20ms to 8,000ms
Inter Echo Time (IET)	FSE 4.4ms – 30ms, EPI 0.4ms – 7ms
RF Flip Angle (FA)	SE 3-120, GE 3-90
Number of Signals averaged	1-99
3D Multi-slab	32
Maximum Number of 2D Slices	256 (512 x 512)
Maximum Number of 3D Slices	512 (512 x 512)
Acquisition Matrices	up to 1024 x 1024
Reconstruction Matrices	up to 1024 x 1024

5 Component dimensions

Gantry	
Length	1,600mm
Width	2,100mm
Height	2,200mm
Bore diameter	610mm
Weight	5150kg
Patient table	
Length	2,350mm
Width	700mm

Height	852mm up position
	495mm down position
Maximum load	180kg
Horizontal movement	2800mm
Horizontal movement speed	200mm/s maximum
Operators desk	
Width	1219mm
Depth	792mm
Height	731mm
Computer	
Qwerty keyboard	
2-button mouse with scroll	
LCD monitor	
19 inch LCD monitor	
MR cabinets	
Gradient amplifier cabinet	Width 700mm
	Depth 1076mm
	Height 1882mm
RF and control unit	Width 700mm
	Depth 1000mm
	Height 1880mm
	IP Unit
	Width 700mm
	Depth 1000mm
	Height 1880mm
Heat exchanger and compressor unit	Width 700mm
	Depth 1000mm
	Height 1880mm
Emergency run down unit	Height 92mm
	Diameter 230mm
	Weight 0.5kg

6 Site considerations

RF shielded scan room	RF noise $\lt; 0.5 \mu\text{V/m}$ from 10-80 MHz
Air conditioning	
Scan room	Ambient operating temperature 20-24°C, max. allowable temperature change 2.5°C/hour
Computer cabinet room	Ambient operating temperature 20-28°C
AC power	
Voltage	3-phase AC 380, 400, 415V (50Hz)
	3-phase AC 460, 480V (60Hz)
Frequency	50/60 Hz +/- 1% or less
Capacity	85kVA
Typical room size	
Scan room	5.0 x 6.2m
	Minimum ceiling height is 2.35m
Computer cabinet	4.0 x 3.0 m
	Minimum ceiling height is 2.2m
Operator's room	3.0 x 2.4 m
	Minimum ceiling height is 2.2m
Magnetic leakage flux - 5 gauss line	
Axially	4m
Radially	2.5m

Room layout

- Gantry
- Patient table
- Alarm box
- Remote switch
- Operator equipment:
 - PC unit
 - Switch unit
 - LCD monitor
 - Keyboard, mouse
 - Multiple tap unit
- IPDU
- RFCU
- GCPAU
- EXCU
- Filter box

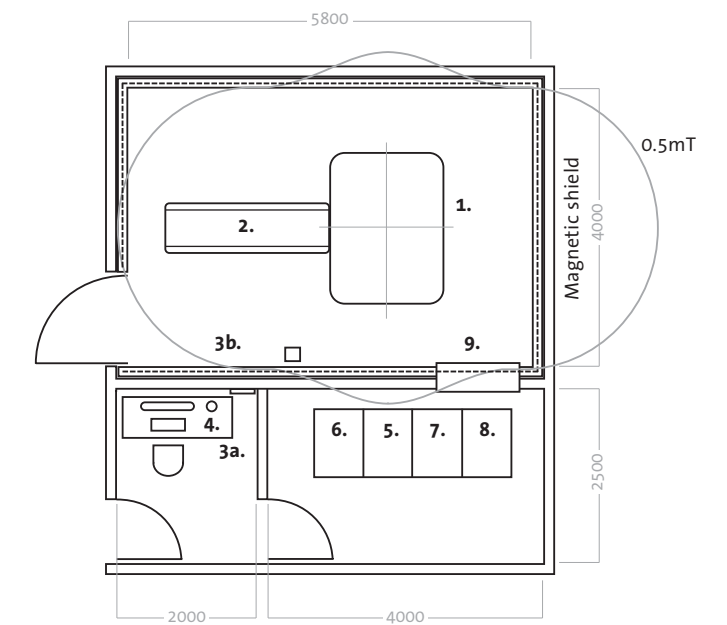

System configuration

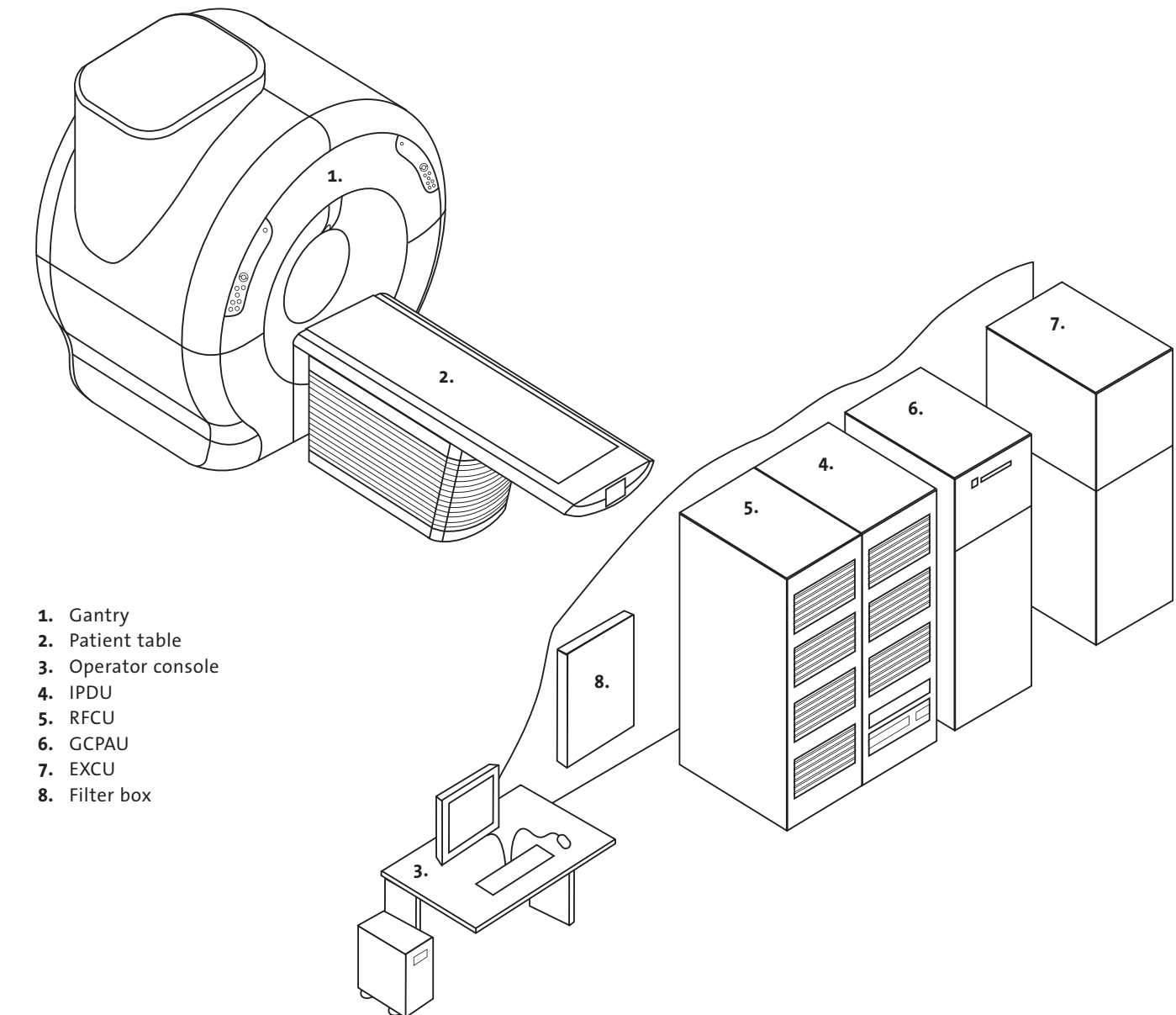

- Gantry
- Patient table
- Operator console
- IPDU
- RFCU
- GCPAU
- EXCU
- Filter box